



## SCHULTHESS PROLINE W-SERIES

### MODELS:

W220  
W300





### DIMENSIONS:

HxWxD: 1815x1050x970mm  
HxWxD: 1815x1050x1150mm

### CAPACITY:

24kg  
33kg

### SUITABLE FOR:

|      |  INDUSTRIAL |  HOSPITALITY |  HEALTHCARE |  ANIMAL CARE |  EDUCATION |  PUBLIC SECTOR |  VENDED LAUNDRY |
|------|--|---|--|---|---|---|--|
| W220 | ✓  | ✓   | ✓  | ✓   | ✓   | ✓   | ✓  |
| W300 | ✓  | ✓   | ✓  | ✓   | ✓   | ✓   | ✓  |

### FEATURES:

- ▶ Freestanding, high-speed
- ▶ Powder-coated steel housing, matt grey
- ▶ Stainless steel drum
- ▶ Intuitive touch operation with 4.3" colour display
- ▶ «Expert» control system
- ▶ 24 standard programmes
- ▶ 24 freely programmable positions

- ▶ Cold, hot or soft water connection
- ▶ Start delay with calendar function
- ▶ 23 language options
- ▶ Designed for over 30,000 operating hours

### OPTIONS:

- ▶ WLAN interface for programme and software updates
- ▶ Connection for 8 liquid detergent dosing pumps
- ▶ Standard machine plinth
- ▶ Mains blocking set (load shedding/ current peak)

**ONECARE<sup>cc</sup>** This machine is eligible for our all inclusive service solution, One Care.

**service  
Master<sup>®</sup>**

This machine is compatible with our smart laundry solution, serviceMaster

LEADER OF THE **WOLF** LAUNDRY GROUP

**BREWER &  
BUNNEY**

**PEE GEE**  
PROFESSIONAL LAUNDRY SOLUTIONS

**FLOW**  
By WOLF

| SCHULTHESS PROLINE             | W220            | W300            |
|--------------------------------|-----------------|-----------------|
| Product number                 | 4206.1          | 4207.1          |
| <b>Properties</b>              |                 |                 |
| Fill ratio (1:9)               | 24kg            | 33kg            |
| Filling quantity (1:10)        | 22kg            | 30kg            |
| Drum volume                    | 220l            | 300l            |
| Drum opening diameter          | 800 mm          | 800 mm          |
| Drum depth                     | 437 mm          | 597 mm          |
| Spin speed                     | 1000 rpm        | 950 rpm         |
| G-factor                       | 447             | 404             |
| Residual moisture              | 48%             | 48%             |
| <b>Electrical Requirements</b> |                 |                 |
| Supply voltage (V)             | 400 3N~ / 50 Hz | 400 3N~ / 50 Hz |
| Connected load                 | 20 kW           | 25 kW           |
| Electric heating               | 17.4 kW         | 22.5 kW         |
| Drive                          | 3 kW            | 3 kW            |
| Protection                     | 32 A            | 50 A            |
| <b>Plumbing Requirements</b>   |                 |                 |
| Water pressure on site         | 0.15 –1.0 MPa   | 0.15 –1.0 MPa   |
| Cold water hard inflow         | >65 litre/min   | >65 litre/min   |
| Hot water inflow (max. 70°C)   | >30 litre/min   | >30 litre/min   |
| Drainage rate (drain valve)    | 260 litre/min   | 260 litre/min   |
| Water connection Ø inch        | 3 inch          | 3 inch          |
| Drain valve diameter Ø inch    | 3/4 inch        | 3/4 inch        |

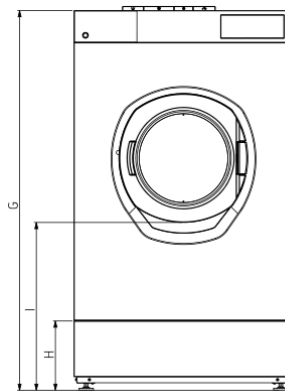
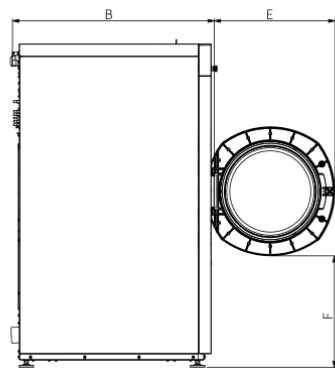
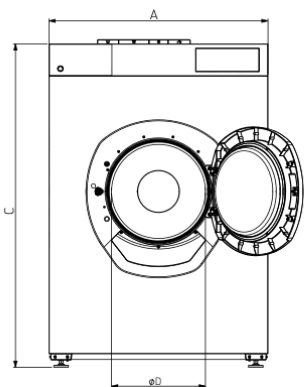

| Dimensions | A    | B    | C    | D   | E   | F   | G    | H   | I   | Weight (kg) |
|------------|------|------|------|-----|-----|-----|------|-----|-----|-------------|
| W220       | 1050 | 970  | 1555 | 450 | 580 | 535 | 1815 | 335 | 805 | 455         |
| W300       | 1050 | 1150 | 1555 | 450 | 580 | 535 | 1815 | 335 | 805 | 545         |